



# Thule Rapid System Kit 1710

## > Instructions

**VOLKSWAGEN Golf VII**, 3-dr Hatchback, 13- / \*15-  
**VOLKSWAGEN Golf VII**, 5-dr Hatchback, 13- / \*15-  
**VOLKSWAGEN GTI VII**, 3-dr Hatchback, \*15-  
**VOLKSWAGEN GTI VII**, 5-dr Hatchback, \*15-

\*North America

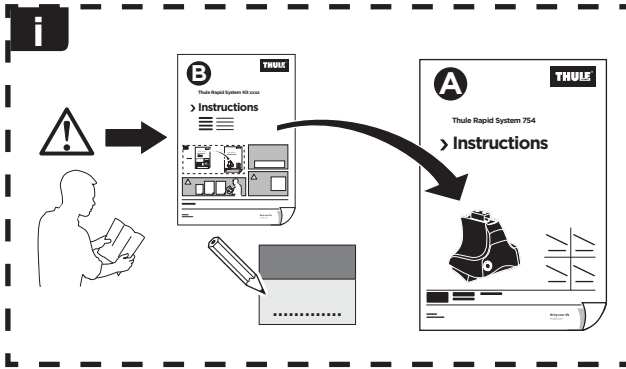

	xx kg	+		7 kg	15,4 lbs
	xx lbs			3 kg	6,6 lbs
=	3-dr	Max.	50 kg	Max.	110 lbs
=	5-dr	Max.	60 kg	Max.	132 lbs

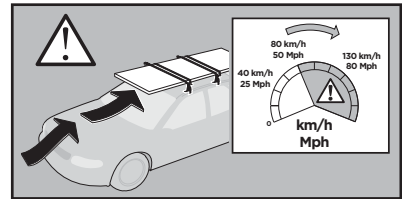
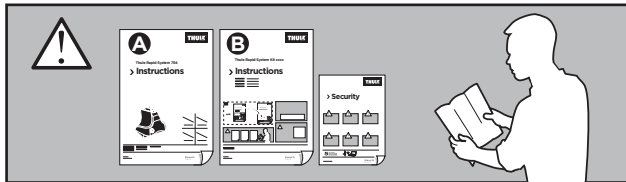

ISO 11154-E

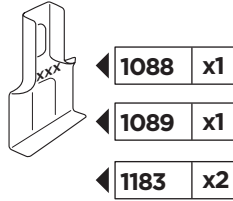
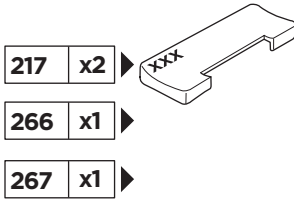
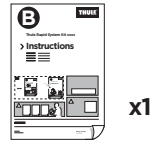

# 1

	X (scale)	X (mm)	X (inch)
<b>VOLKSWAGEN Golf VII</b> , 3-dr Hatchback, 13- / *15-	<b>39</b>	<b>1041</b>	<b>41</b>
<b>VOLKSWAGEN Golf VII</b> , 5-dr Hatchback, 13- / *15-	<b>39</b>	<b>1041</b>	<b>41</b>
<b>VOLKSWAGEN GTI VII</b> , 3-dr Hatchback, *15-	<b>39</b>	<b>1041</b>	<b>41</b>
<b>VOLKSWAGEN GTI VII</b> , 5-dr Hatchback, *15-	<b>39</b>	<b>1041</b>	<b>41</b>

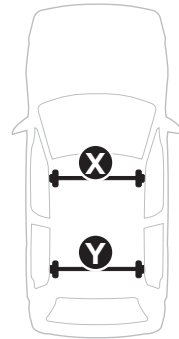
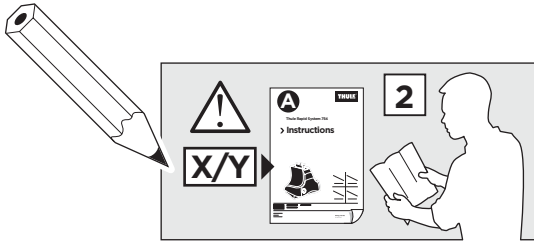

	Y (scale)	Y (mm)	Y (inch)
<b>VOLKSWAGEN Golf VII</b> , 3-dr Hatchback, 13- / *15-	<b>31</b>	<b>961</b>	<b>37 <sup>7</sup>/<sub>8</sub></b>
<b>VOLKSWAGEN Golf VII</b> , 5-dr Hatchback, 13- / *15-	<b>31</b>	<b>961</b>	<b>37 <sup>7</sup>/<sub>8</sub></b>
<b>VOLKSWAGEN GTI VII</b> , 3-dr Hatchback, *15-	<b>31</b>	<b>961</b>	<b>37 <sup>7</sup>/<sub>8</sub></b>
<b>VOLKSWAGEN GTI VII</b> , 5-dr Hatchback, *15-	<b>31</b>	<b>961</b>	<b>37 <sup>7</sup>/<sub>8</sub></b>

2

**VOLKSWAGEN Golf VII**, 3-dr Hatchback, 13- / \*15-  
**VOLKSWAGEN GTI VII**, 3-dr Hatchback, \*15-

SRA

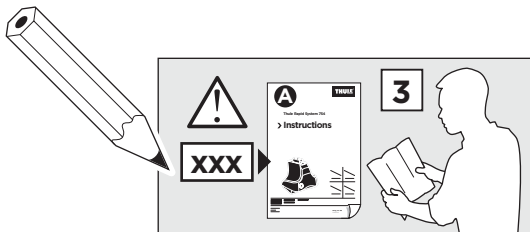
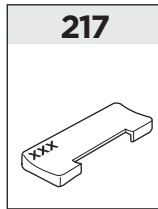
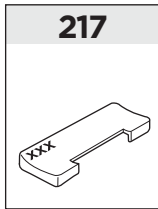
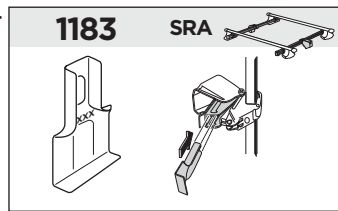
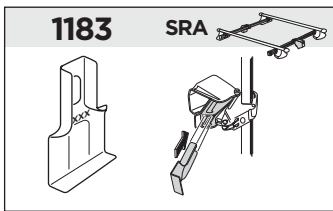
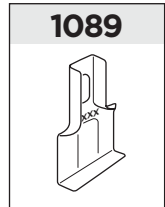
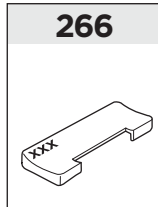
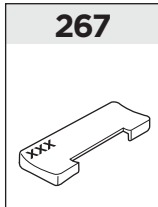
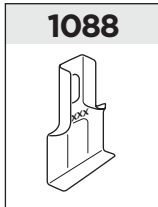
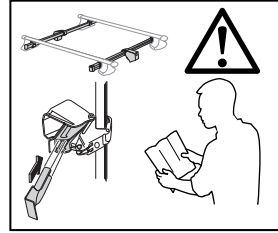

**2**

**VOLKSWAGEN Golf VII**, 5-dr Hatchback, 13- / \*15-  
**VOLKSWAGEN GTI VII**, 5-dr Hatchback, \*15-

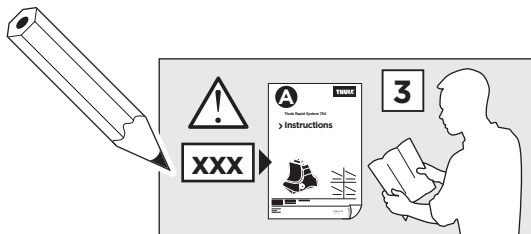
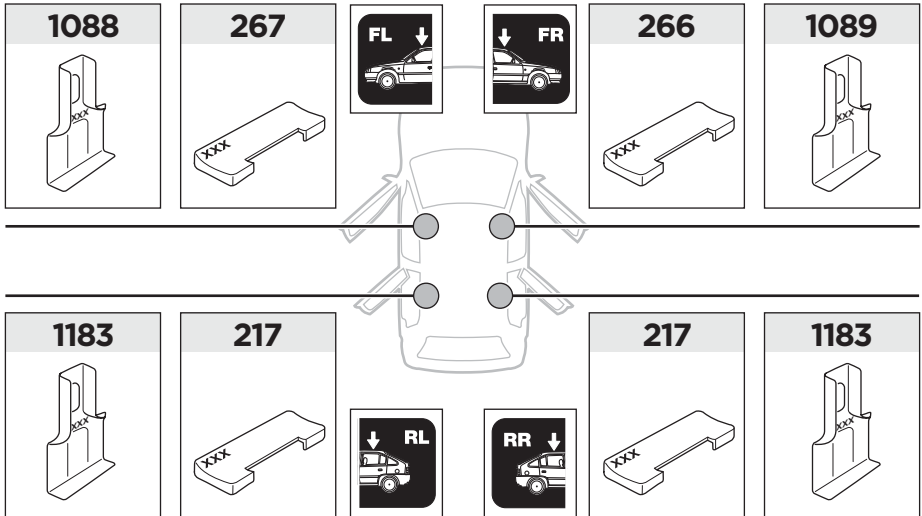

3

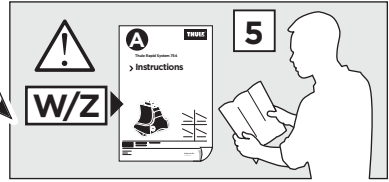
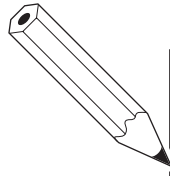

	W (mm)	Z (mm)	Y (mm)	W (inch)	Z (inch)	Y (inch)
<b>VW Golf VII, 3-dr Hatchback, 13- / *15-</b>	<b>230</b>	<b>710</b>	<b>460</b>	<b>9</b>	<b>28</b>	<b>18 1/8</b>
<b>VW GTI VII, 3-dr Hatchback, *15-</b>	<b>230</b>	<b>710</b>	<b>460</b>	<b>9</b>	<b>28</b>	<b>18 1/8</b>

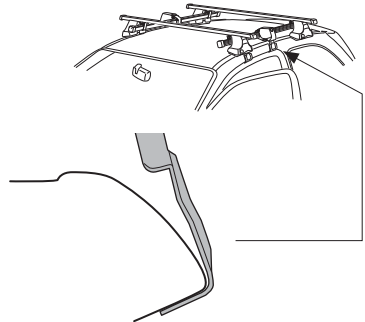
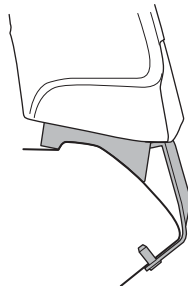
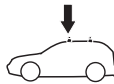
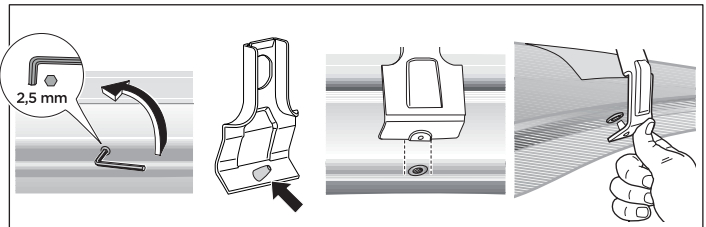
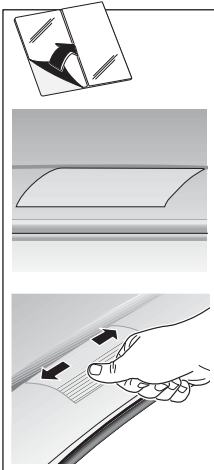
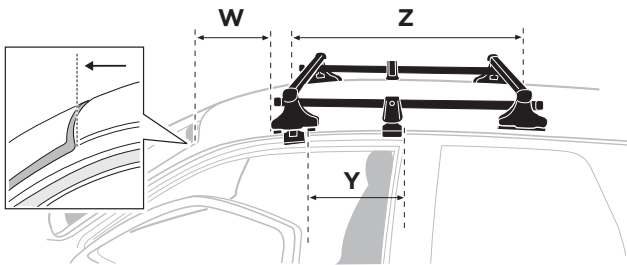

3

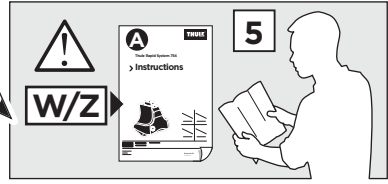
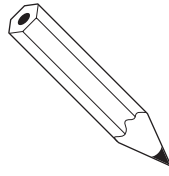

	W (mm)	Z (mm)	W (inch)	Z (inch)
<b>VOLKSWAGEN Golf VII</b> , 5-dr Hatchback, 13- / *15-	<b>230</b>	<b>710</b>	<b>9</b>	<b>28</b>
<b>VOLKSWAGEN GTI VII</b> , 5-dr Hatchback, *15-	<b>230</b>	<b>710</b>	<b>9</b>	<b>28</b>

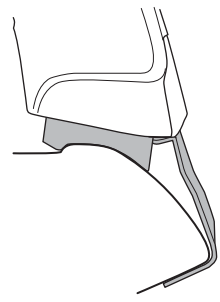
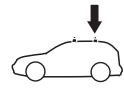
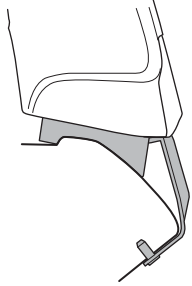
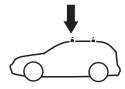
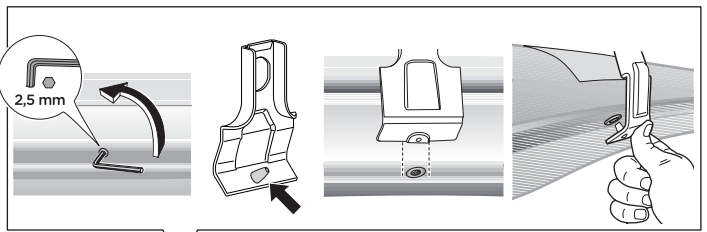
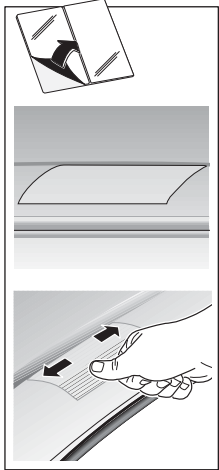
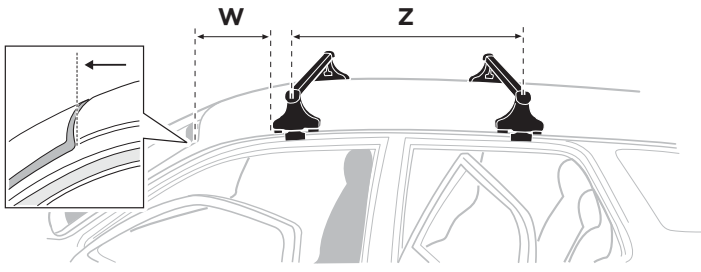

4



3-dr

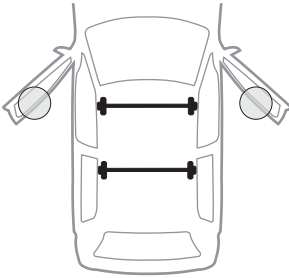

5-dr

