

# Kit 1626

CITROËN C4, 5-dr Hatchback, 10-

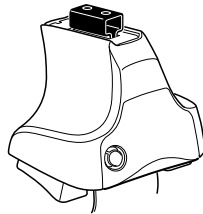

**754** Rapid System  
**480R** Rapid Traverse (North America)

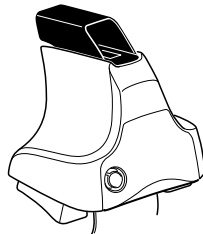
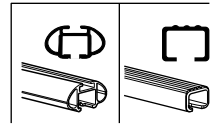

**480** Traverse (North America)

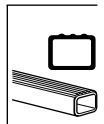



1



2



754 Rapid System  
480R Rapid Traverse  
(North America)



x4

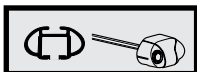

x4

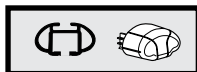

x4



480 Traverse  
(North America)

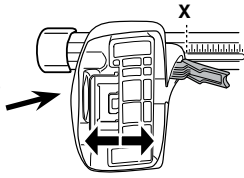

x4

**3****754 Rapid System**

	X
CITROËN C4, 5-dr Hatchback, 10-	38

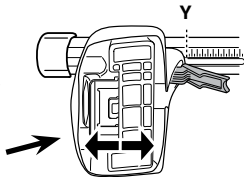

	Y
CITROËN C4, 5-dr Hatchback, 10-	32,5

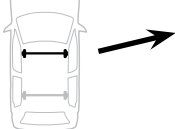
**3****480R Rapid Traverse****480 Traverse****(North America)**

	X inch	X mm
CITROËN C4, 5-dr Hatchback, 10-	40 <sup>5</sup> / <sub>8</sub> "	1031 mm

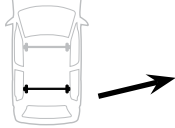

	Y inch	Y mm
CITROËN C4, 5-dr Hatchback, 10-	38 <sup>3</sup> / <sub>8</sub> "	976 mm

**4**

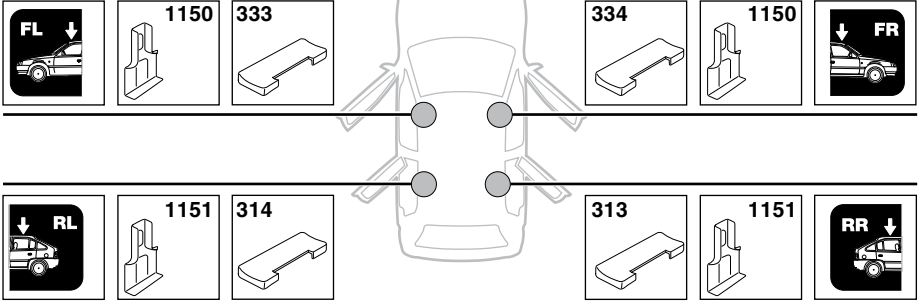
**5****CITROËN C4, 5-dr Hatchback, 10-**

6

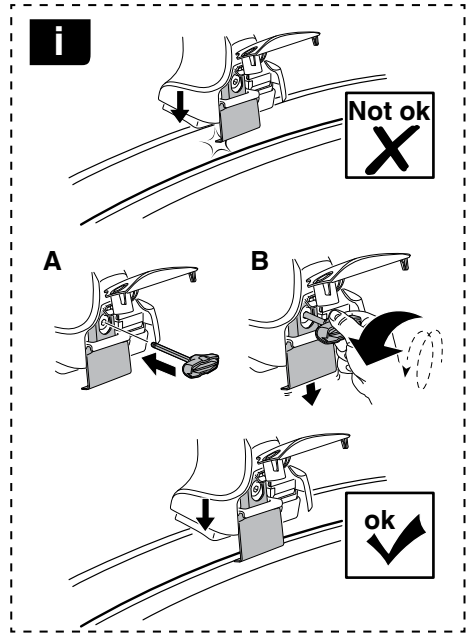
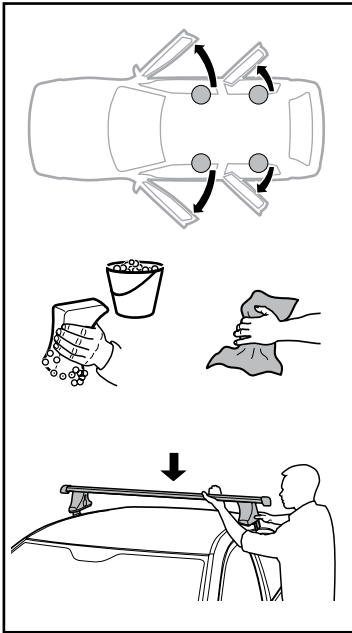

	X mm	Y mm	X inch	Y inch
CITROËN C4, 5-dr Hatchback, 10-	210 mm	725 mm	8 1/4"	28 1/2"

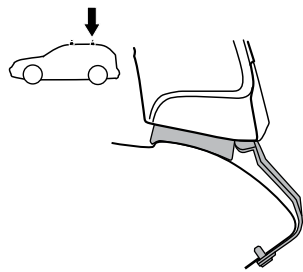
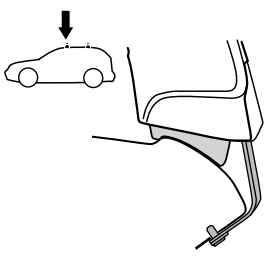
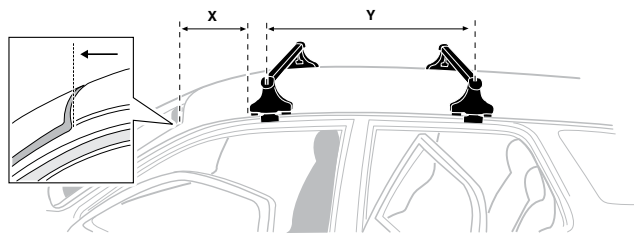

7



<b>GB/US</b>	Tighten alternately
<b>D</b>	Die Schrauben abwechselnd anziehen
<b>F</b>	Serrer alternativement chaque côté
<b>NL</b>	Afwisselend aan de linker- en de rechterkant aandraaien
<b>I</b>	Alternare il serraggio delle viti
<b>E</b>	Apretar alternativamente
<b>PT</b>	Aperte alternadamente
<b>S</b>	Dra åt växelvis
<b>FIN</b>	Kierrä vuorotellen
<b>EST</b>	Pinguldage vaheldumisi
<b>LAT</b>	Pielveiciet pamišus
<b>LIT</b>	Užsukinėkite pakaitomis
<b>PL</b>	Śruby dokręcaj naprzemiennie
<b>RU</b>	Загряивайте попеременно

<b>CZ</b>	Pokręřta багаžnika dokręcaj naprzemiennie.
<b>SK</b>	Dofahajte striedavo
<b>SLO</b>	Privijajte izmenično.
<b>HR</b>	Naizmjenično zategnite
<b>HU</b>	Egymástól függetlenül szorítandó
<b>GR</b>	Σφιγίγες εναλάξ
<b>TR</b>	Dönüşümlü sıkın

**中文** 交替拧紧

**한국어** 번갈아 가며 조이십시오.

**日本語** 交互に締め付けてください。

**ไทย** ชันในแบบสลับ

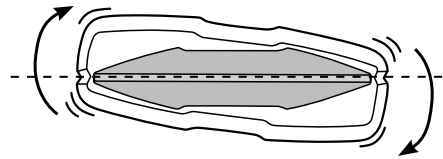
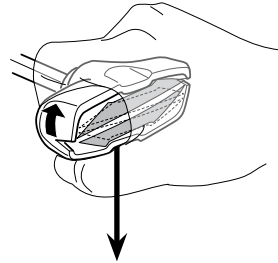
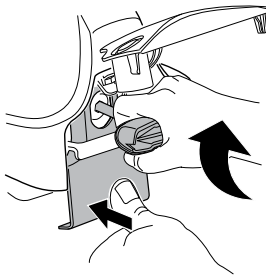
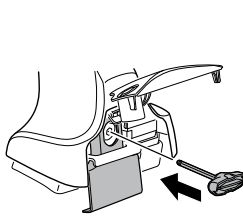

≈ 3 Nm

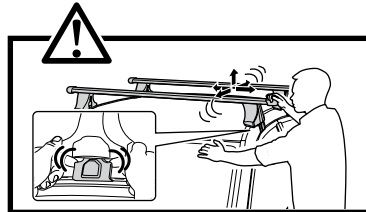
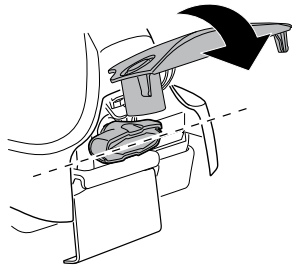

8

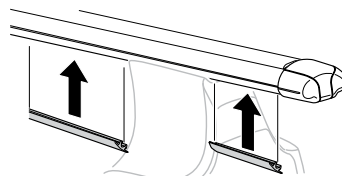
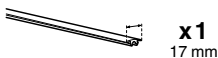



**THULE**  
SWEDEN  
**ONE  
KEY  
SYSTEM**



		(x4)
		(x6)
		(x8)
NA		(x10)
EUR		(x12)
ASIA		



WW ▶ Thule Sweden AB, Box 69, 330 33 Hillerstorp, SWEDEN  
NA ▶ Thule Inc., 42 Silvermine Road, Seymour, Connecticut 06483, USA

info@thule.com  
customer.service@thule.com

www.thule.com