

# Kit 1485

MITSUBISHI Delica, 5-dr MPV, 07-

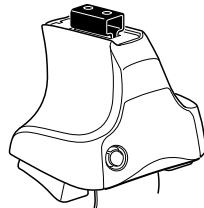

480R Rapid Traverse  
754 Rapid System

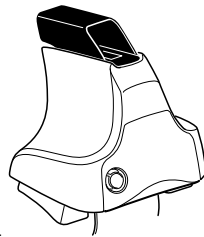
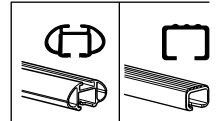

480 Traverse

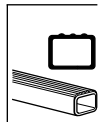



1



480R Rapid Traverse  
754 Rapid System



480 Traverse

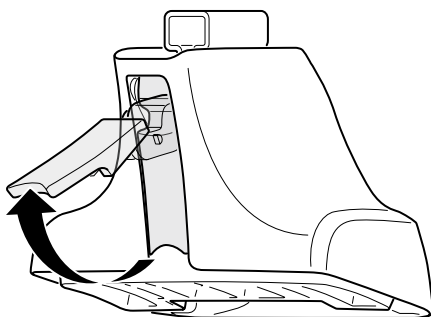

2

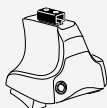

480R Rapid Traverse  
754 Rapid System



480 Traverse

+

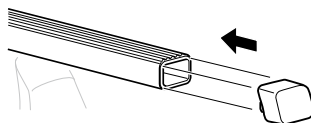
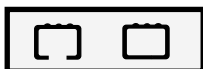
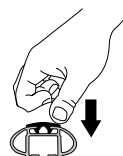
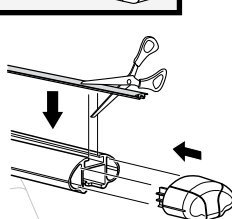
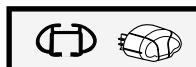
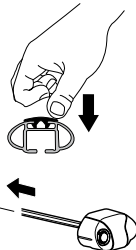
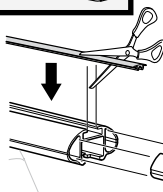
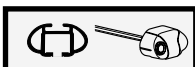
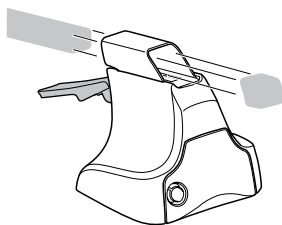
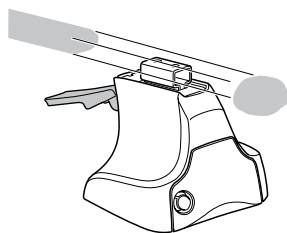

**3**

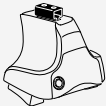

754 Rapid System

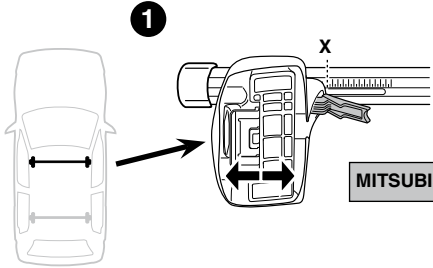

MITSUBISHI Delica, 5-dr MPV, 07-	X
	55

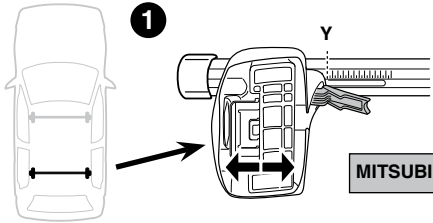

MITSUBISHI Delica, 5-dr MPV, 07-	Y
	53,5



480R Rapid Traverse



480 Traverse

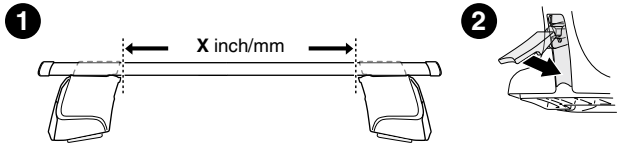

MITSUBISHI Delica, 5-dr MPV, 07-	X inch	X mm
	47 1/4"	1200 mm

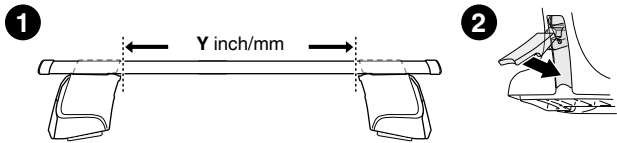

MITSUBISHI Delica, 5-dr MPV, 07-	Y inch	Y mm
	46 3/4"	1185 mm

4

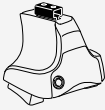

480R Rapid Traverse  
754 Rapid System



480 Traverse

MITSUBISHI Delica, 5-dr MPV, 07-

346



1118



346

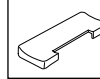

1118



347



1118



347

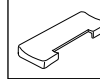

1118

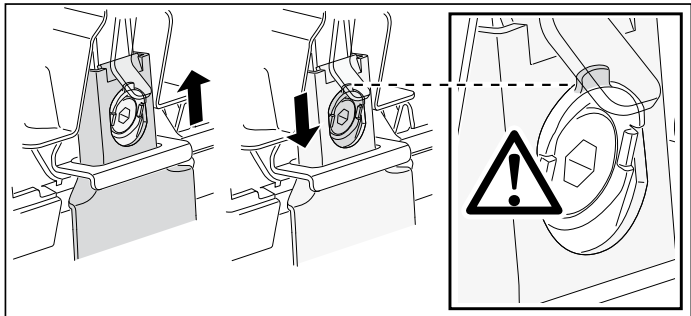
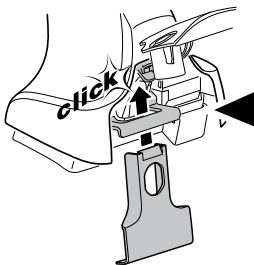
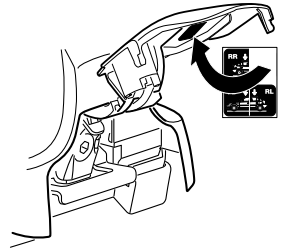
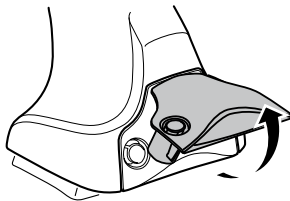
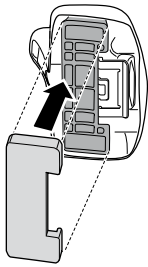

5

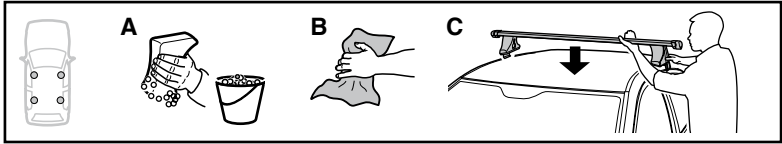

	X mm	Y mm	X inch	Y inch
MITSUBISHI Delica, 5-dr MPV, 07-	860 mm	700 mm	33 <sup>7</sup> / <sub>8</sub> "	27 <sup>1</sup> / <sub>2</sub> "

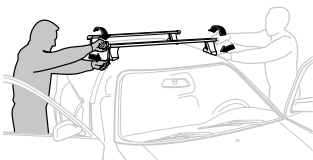
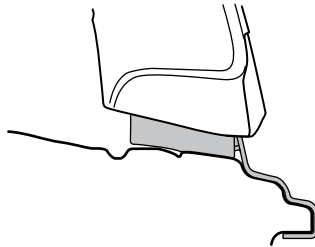
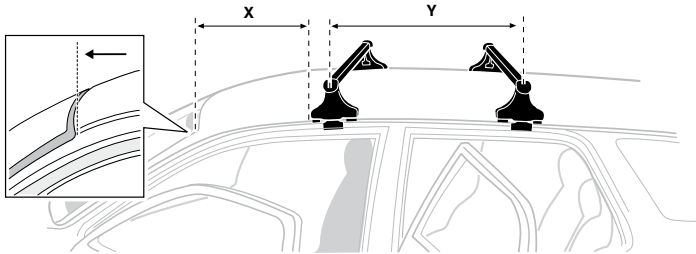

- |              |   |            |   |
|--------------|---|------------|---|
| <b>GB/US</b> | Tighten alternately                                     | <b>CZ</b>  | Pokreťta bagazníka dokrečaj dokrečaj naprzemiennie. |
| <b>D</b>     | Die Schrauben abwechselnd anziehen                      | <b>SK</b>  | Dofahujte striedavo                                 |
| <b>F</b>     | Serrer alternativement chaque côté                      | <b>SLO</b> | Privijajte izmenično.                               |
| <b>NL</b>    | Afwisselend aan de linker- en de rechterkant aandraaien | <b>HR</b>  | Naizmjenočno zategniti                              |
| <b>I</b>     | Alternare il serraggio delle viti                       | <b>HU</b>  | Egymástól függetlenül szorítandó                    |
| <b>E</b>     | Apretar alternativamente                                | <b>GR</b>  | Σφιγγεται εναλλάξ                                   |
| <b>PT</b>    | Aperte alternadamente                                   | <b>TR</b>  | Dönüşümlü sıkın                                     |
| <b>S</b>     | Dra åt växelvis   | <b>中文</b>  | 交替拧紧  |
| <b>FIN</b>   | Kierrä vuorotellen                                      | <b>한국어</b> | 번갈아 가며 조이십시오.                                       |
| <b>EST</b>   | Pinguldage vaheldumisi                                  | <b>日本語</b> | 交互に締め付けてください。                                       |
| <b>LAT</b>   | Pievēlciet pamāšus                                      | <b>ไทย</b> | ขันในแบบสลับ  |
| <b>LIT</b>   | Užsukinėkite pakaitomis                                 |            |   |
| <b>PL</b>    | Śruby dokrećaj naprzemiennie                            |            |   |
| <b>RU</b>    | Затягивайте попеременно                                 |            |   |

6

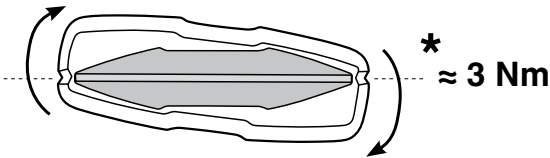
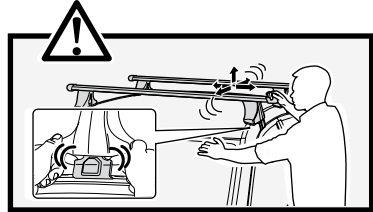
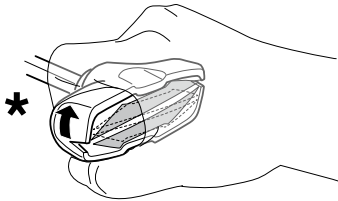
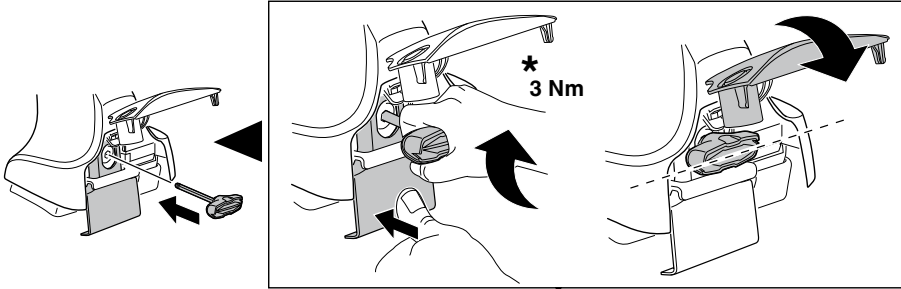
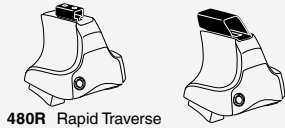

7

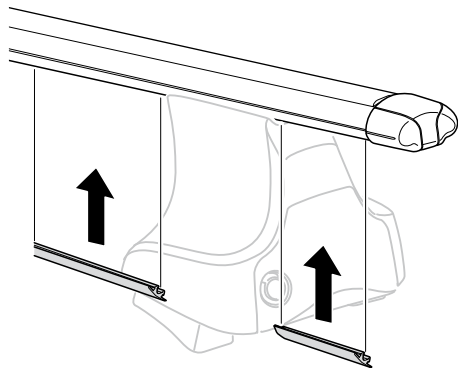
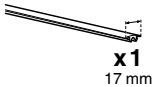

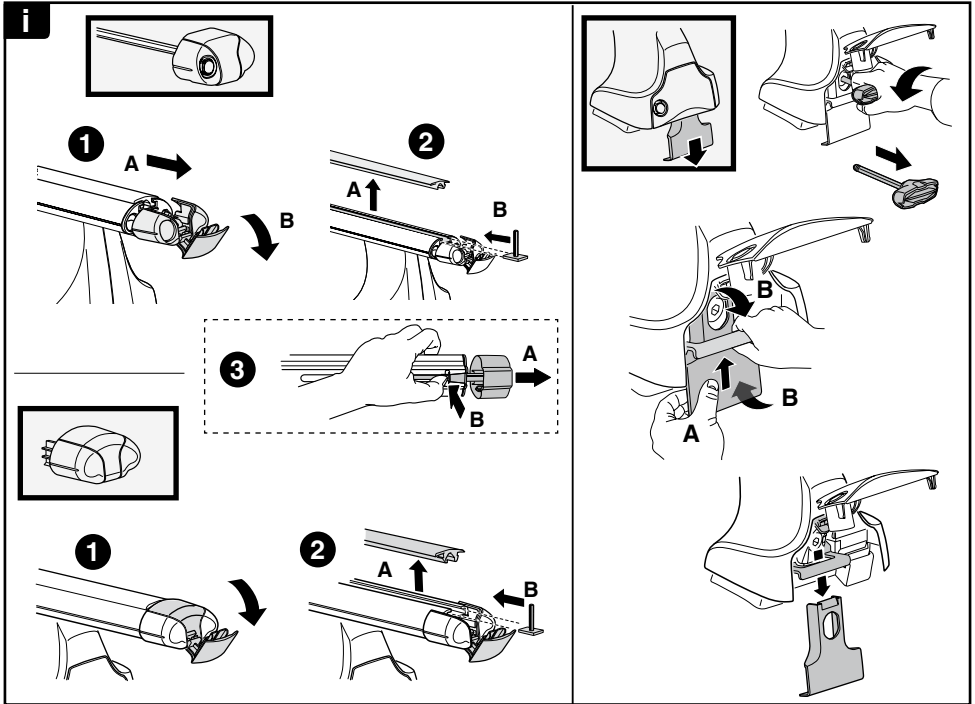
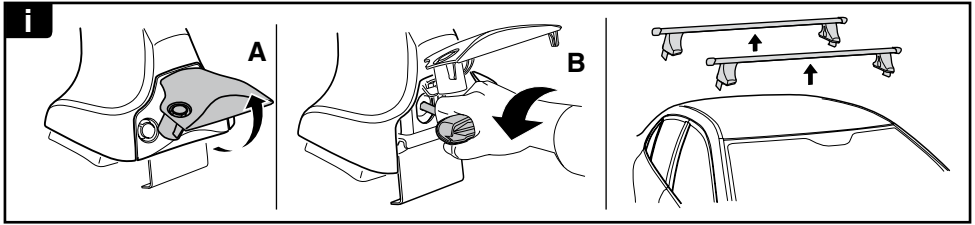

**THULE**  
SWEDEN  
**ONE  
KEY  
SYSTEM**

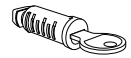
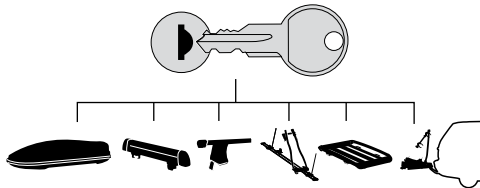

- 544** (x4)
- 596** (x6)
- 588** (x8)
- NA **510** (x10)
- EUR **452** (x12)
- ASIA

