

Thule Rapid System Kit 1443

> Instructions

LAND ROVER Freelander 2, 5-dr SUV, 07-

LAND ROVER LR2, 5-dr SUV, *07-

*North America

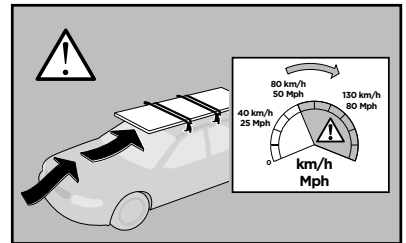
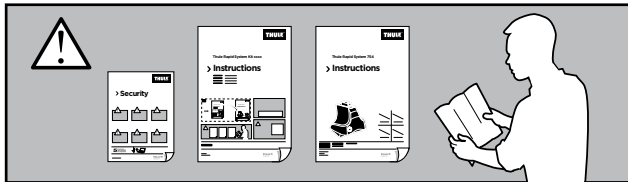
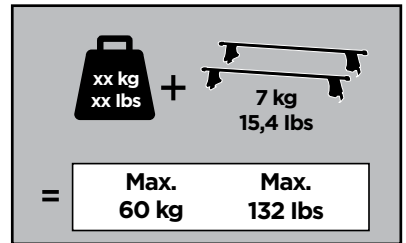
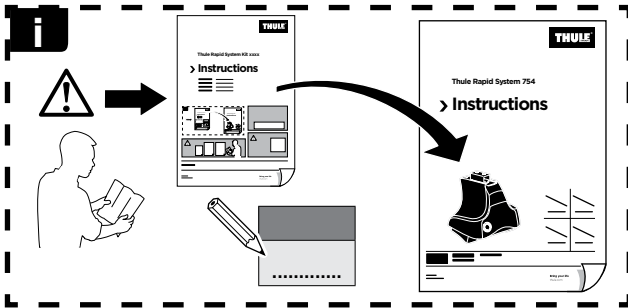

ISO 11154-E

141443

C.20120524
519-1443-02

Bring your life

thule.com



x1

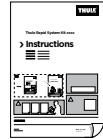
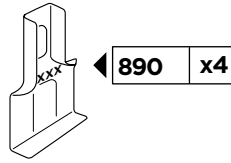
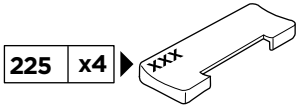

x1

1

| | X (scale) | X (mm) | X (inch) |
|--|-------------|-------------|---------------|
| LAND ROVER Freelander 2 , 5-dr SUV, 07- | 45,5 | 1106 | 43 1/2 |
| LAND ROVER LR2 , 5-dr SUV, *07- | 45,5 | 1106 | 43 1/2 |

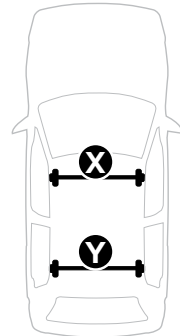
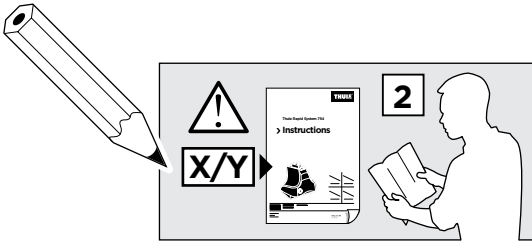

| | Y (scale) | Y (mm) | Y (inch) |
|--|-------------|-------------|---------------|
| LAND ROVER Freelander 2 , 5-dr SUV, 07- | 42,5 | 1076 | 42 3/8 |
| LAND ROVER LR2 , 5-dr SUV, *07- | 42,5 | 1076 | 42 3/8 |

2

LAND ROVER Freelander 2, 5-dr SUV, 07-
LAND ROVER LR2, 5-dr SUV, *07-

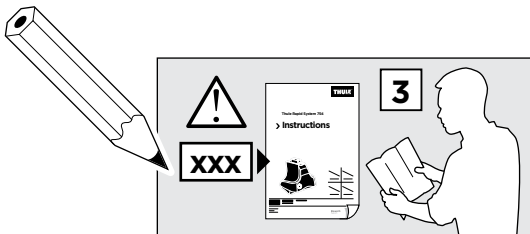
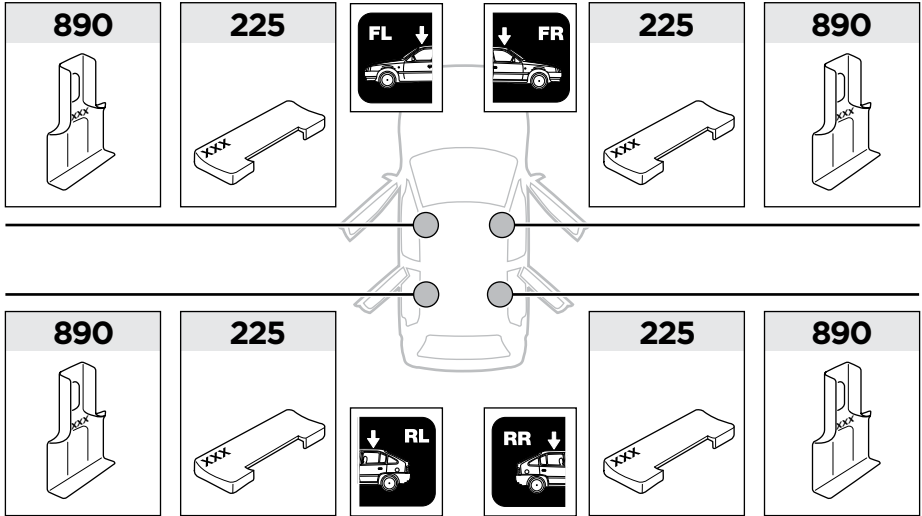

3

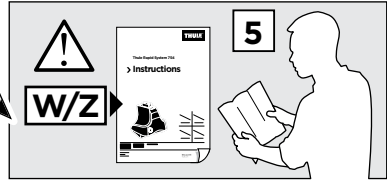
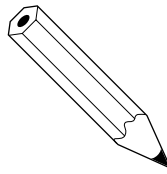

| | W (mm) | Z (mm) | W (inch) | Z (inch) |
|--|------------|------------|---------------|---------------|
| LAND ROVER Freelander 2 , 5-dr SUV, 07- | 310 | 700 | 12 1/4 | 27 1/2 |
| LAND ROVER LR2 , 5-dr SUV, *07- | 310 | 700 | 12 1/4 | 27 1/2 |

